

Nubus® Paneelgordijnen

NL Montage - Gebruik - Onderhoud



NL Drukfouten, en wijzigingen voorbehouden

NL

Geachte klant,

Dit product is speciaal voor u op maat gemaakt. Door het gebruik van hoogwaardige materialen en een design met een perfecte werking en elegantie bent u verzekerd van een lange levensduur en zult u veel plezier van dit product hebben.



Lees deze aanwijzingen aandachtig door voordat u de Paneelgordijn(en) bevestigt



Paneelgordijn(en) moeten door vakkundig personeel worden bevestigd.
Een onjuiste montage kan tot ongelukken leiden.

Aanpassingen aan de jaloezie moeten door de jaloeziefabrikant worden goedgekeurd.
Er worden geen bevestigingsschroeven meegeleverd. Gebruik altijd geschikte schroeven en pluggen voor het materiaal van de wand of het plafond waaraan de Paneelgordijn(en) wordt bevestigd!



WAARSCHUWING



Zie bladzijde 10-11!



Montage

1

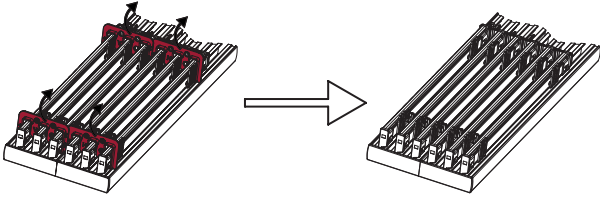

2

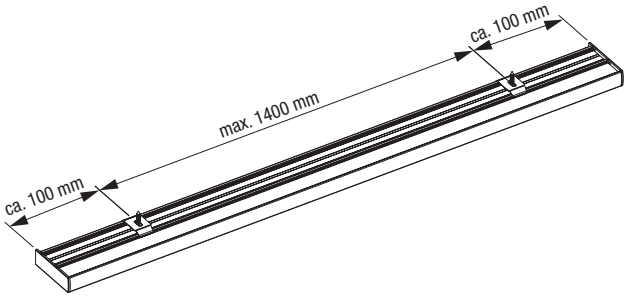

	0	1601	3001	4401	5801
	- 1600	- 3000	- 4400	- 5800	- 5900
	2	3	4	5	6

2a

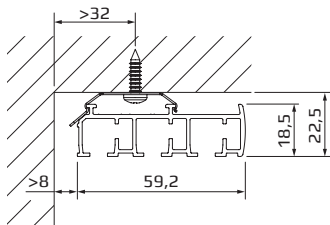
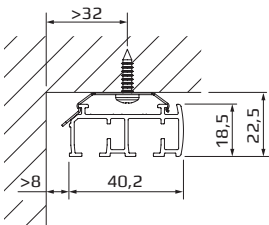
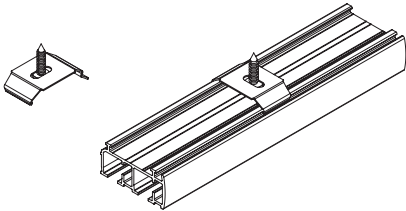

3

Montage

2b

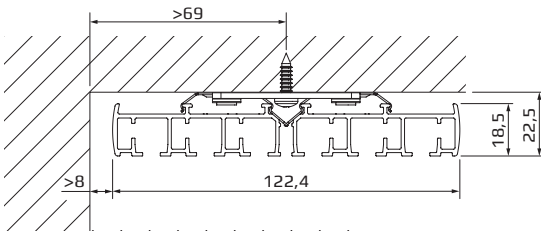
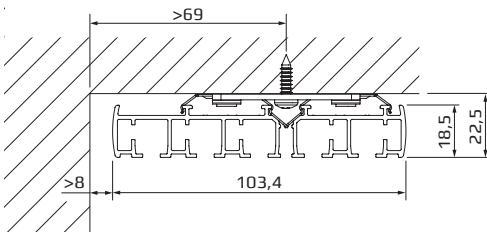
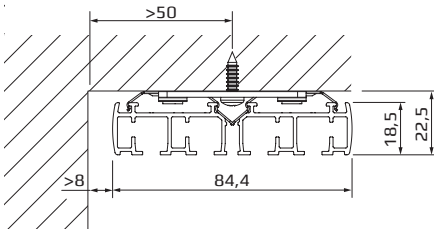
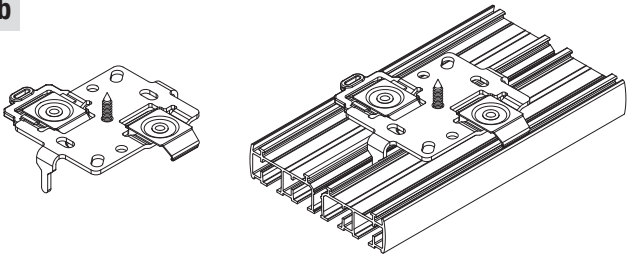

2c

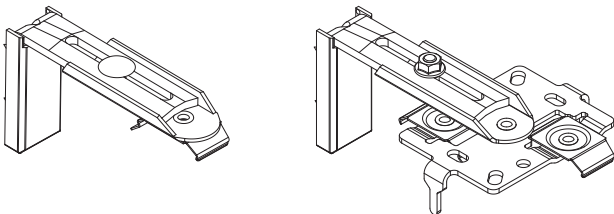

Montage

3

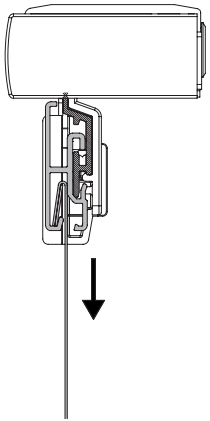
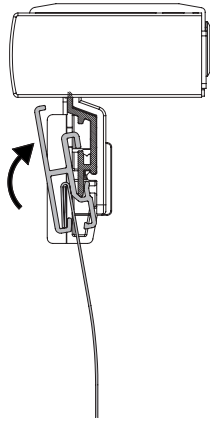
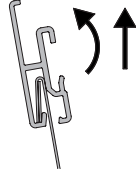
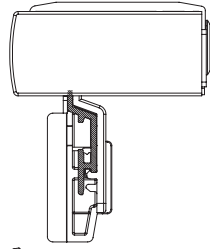
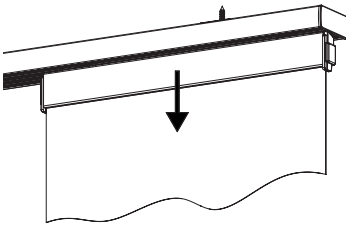
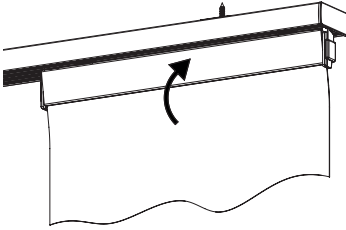
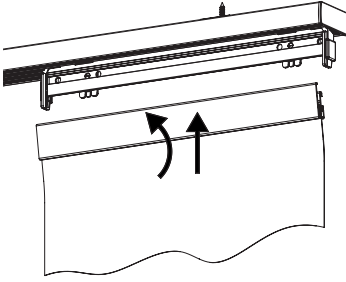

Gebruik

4a

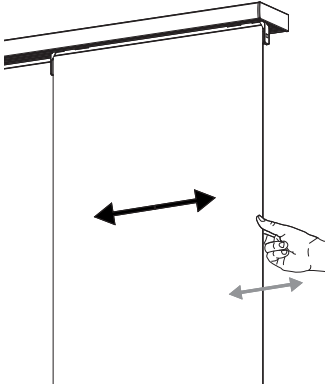

4b

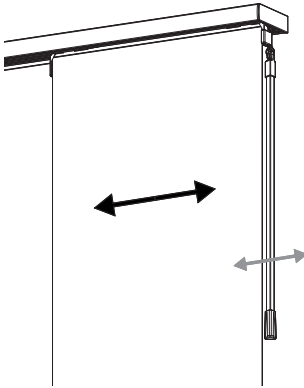

4c

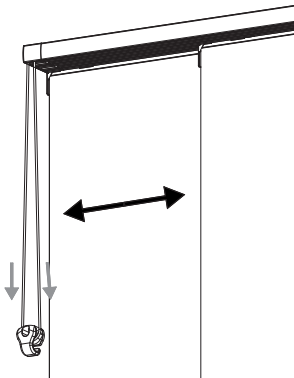

5

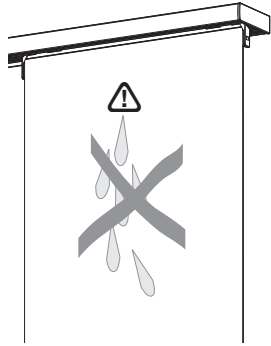
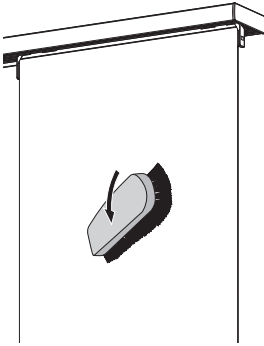

Demontage

6A

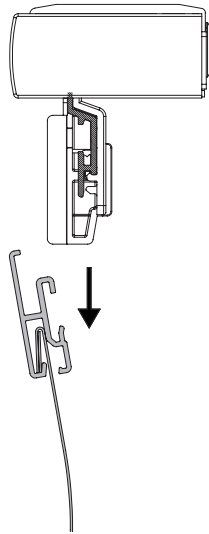
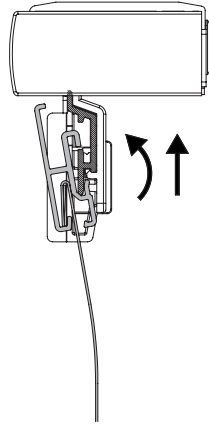
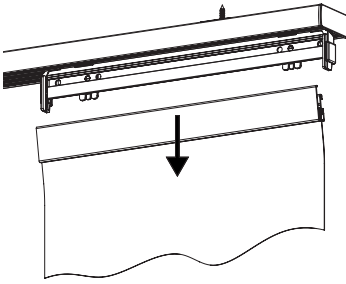
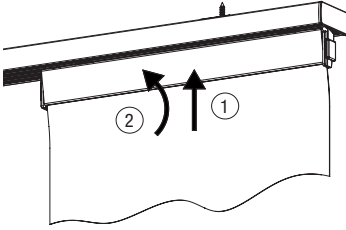

Demontage

6B

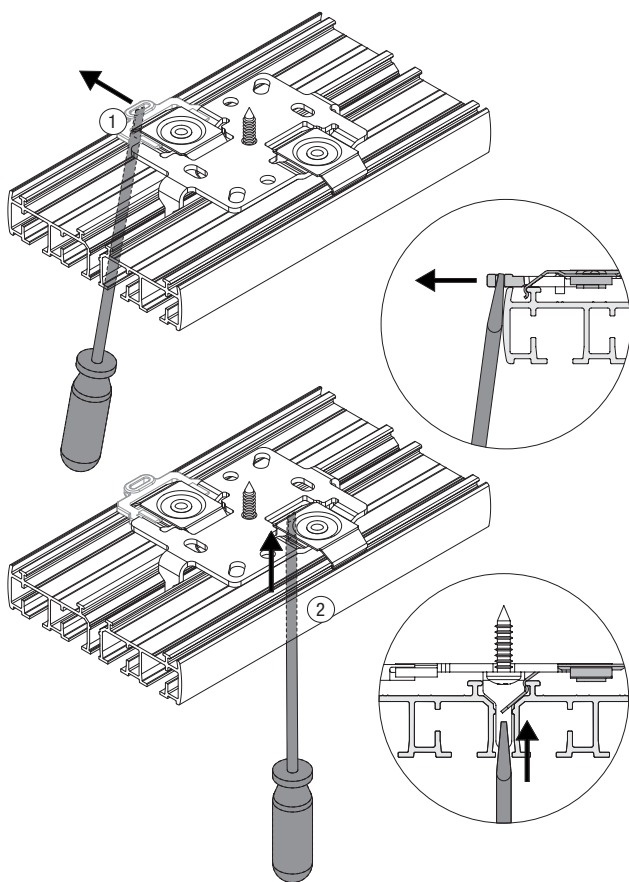
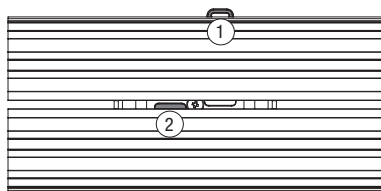

NL



WAARSCHUWING



- Jonge kinderen kunnen verstrikt raken in de lus van de trekkoorden, kettingen, banden en koorden waarmee de raambekleding bediend wordt. Ook kunnen ze koorden om hun keel wikkelen.
- Houd, om wurging en verstikking te voorkomen, de koorden buiten het bereik van jonge kinderen.
- Verwijder bedden, wiegen en ander meubilair uit de buurt van de koorden van raambekleding.
- Knoop de koorden niet aan elkaar. Zorg dat de koorden niet met elkaar verstrengeld raken of een lus vormen.
- Installeer en gebruik de bijgeleverde veiligheidsonderdelen bij deze raamdecoratie overeenkomstig de installatie-instructies om het risico op ongevallen te beperken.



In overeenstemming met EN 13120

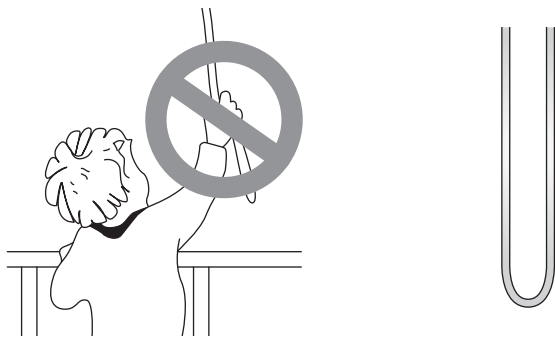

A

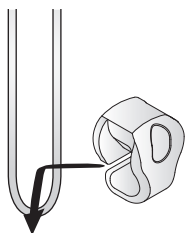

B

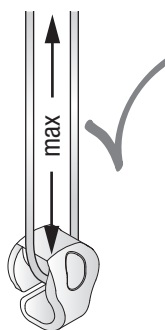
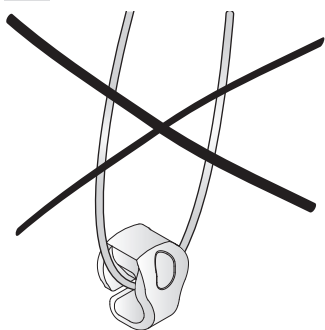

C

